

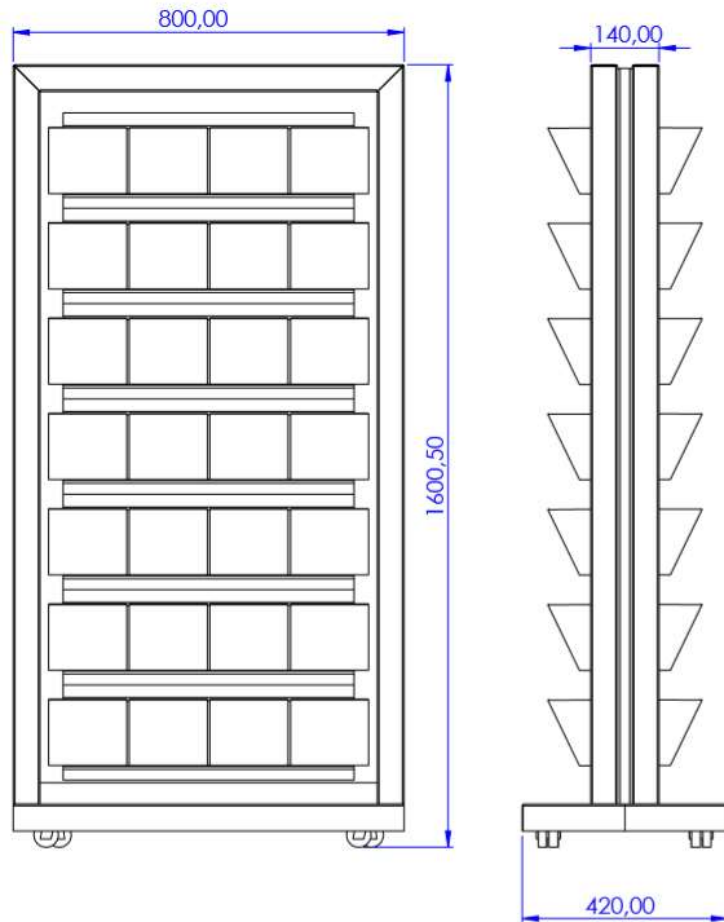

MoBox 80 x 160

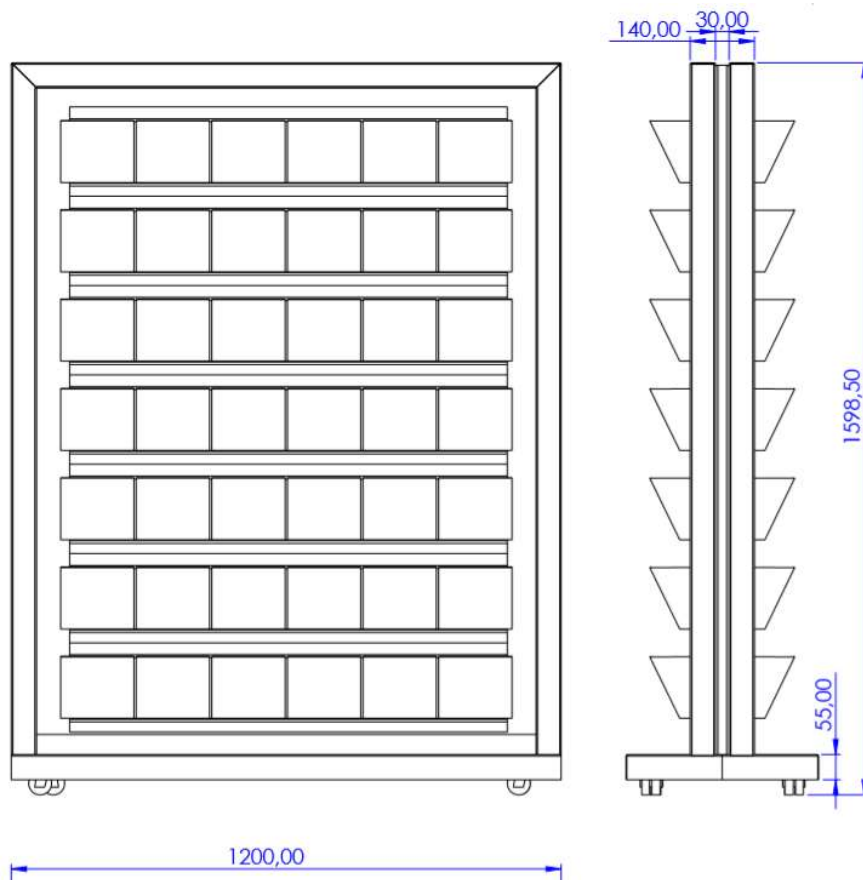

MoBox 120 x 160



MoBox 120 x 180

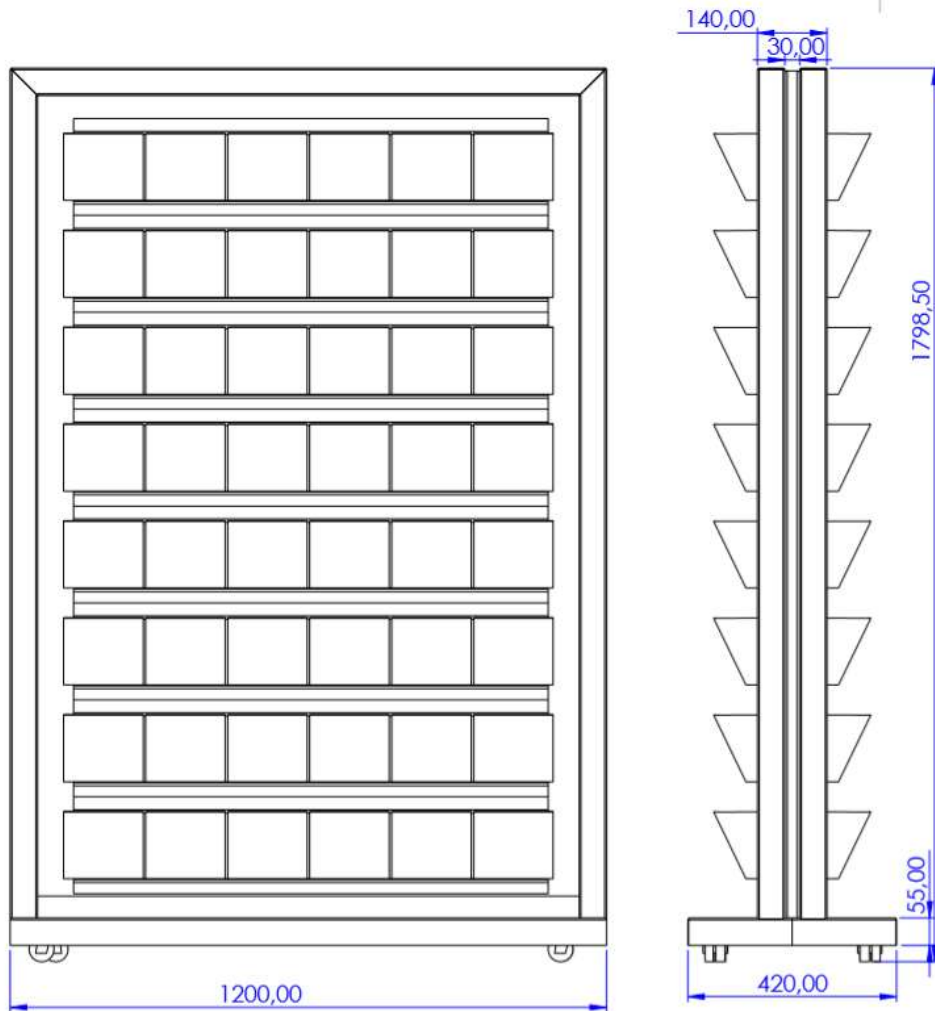

MoBox 160 x 200

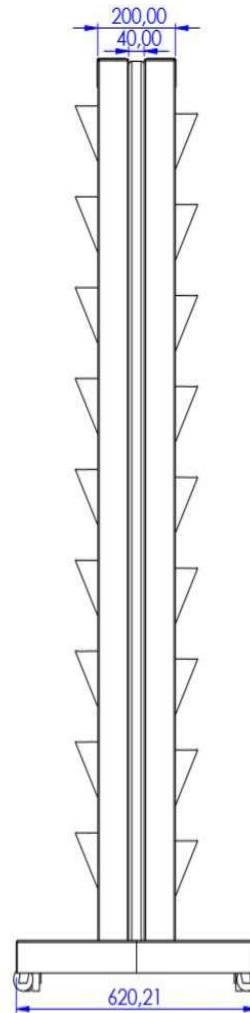
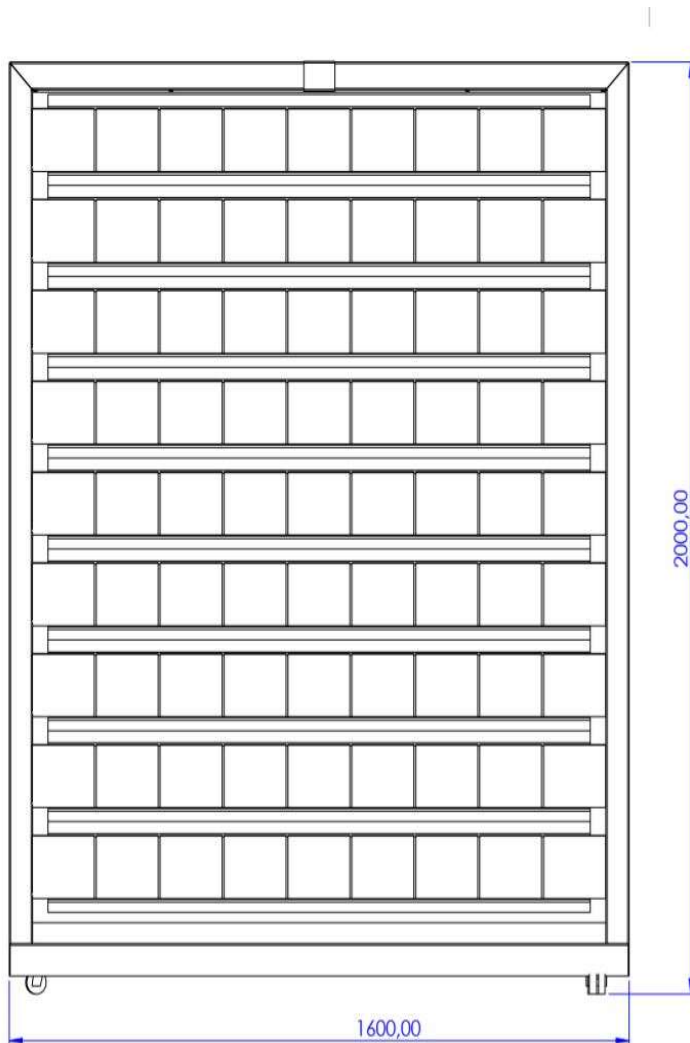

MoBox / AK 160 x 200



DATA SHEET

ARCHISONIC® 12 mm

Dimensions:	1200mm x 2800mm
Composition:	100% PET (min. 60% post-consumer)
Density:	2400g/m ²
Thickness:	12mm (+/-7%)
Fire test: DIN EN 13501-1 ASTME84	B-s1, d0 Class A
VOC Emission: CDPH 01350 ISO 16000 EN 16516	Pass (CDHPH/EHLB/Standard Method V1.2.)
Environmental:	Cradle to Cradle Certified Product qualifies for LEED v4 specifications on VOC emissions in LEED EQ credit (Low-emitting products)



Colour Fastness: EN ISO 105-B02, A1	Grade 6
Material reutilisation:	53 PET Bottles/m ²
Sound absorption DIN EN ISO 11654	aw 0.30 (no air gap)

Sound Absorption Class: A

Supported by:

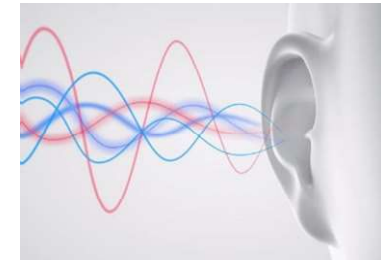
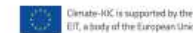

COLOUR & SURFACE DEVIATION

ARCHISONIC® is manufactured at the highest quality standards, yet slight color and surface deviations caused by the high degree of recycled fiber are an inevitable part of the product characteristics and do not claim warranty services - it is the natural and less manicured look that designers appreciate about this product around the world. Irregularities are best visible in our light color products.







1600,00

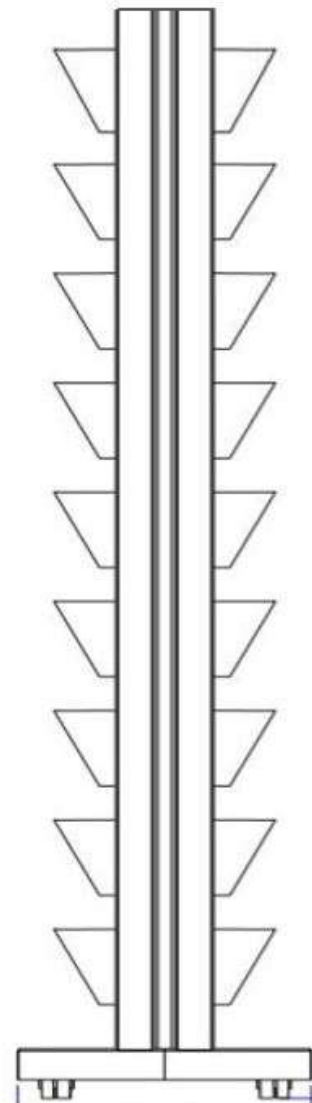

620,21

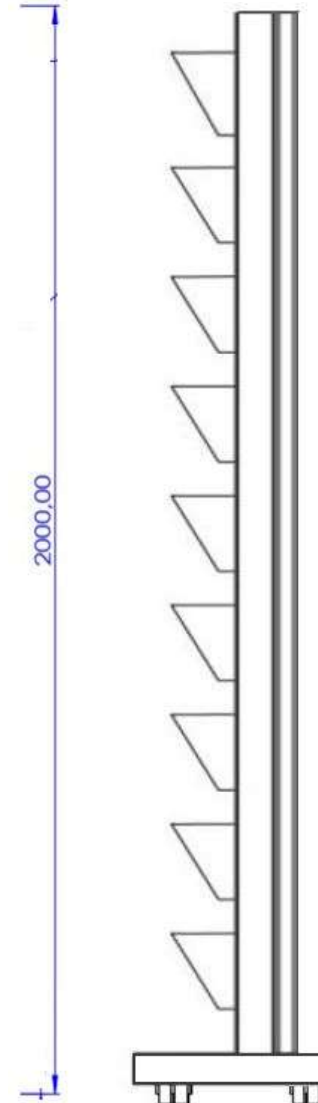

2000,00

420,00

MoBox 160 x 200



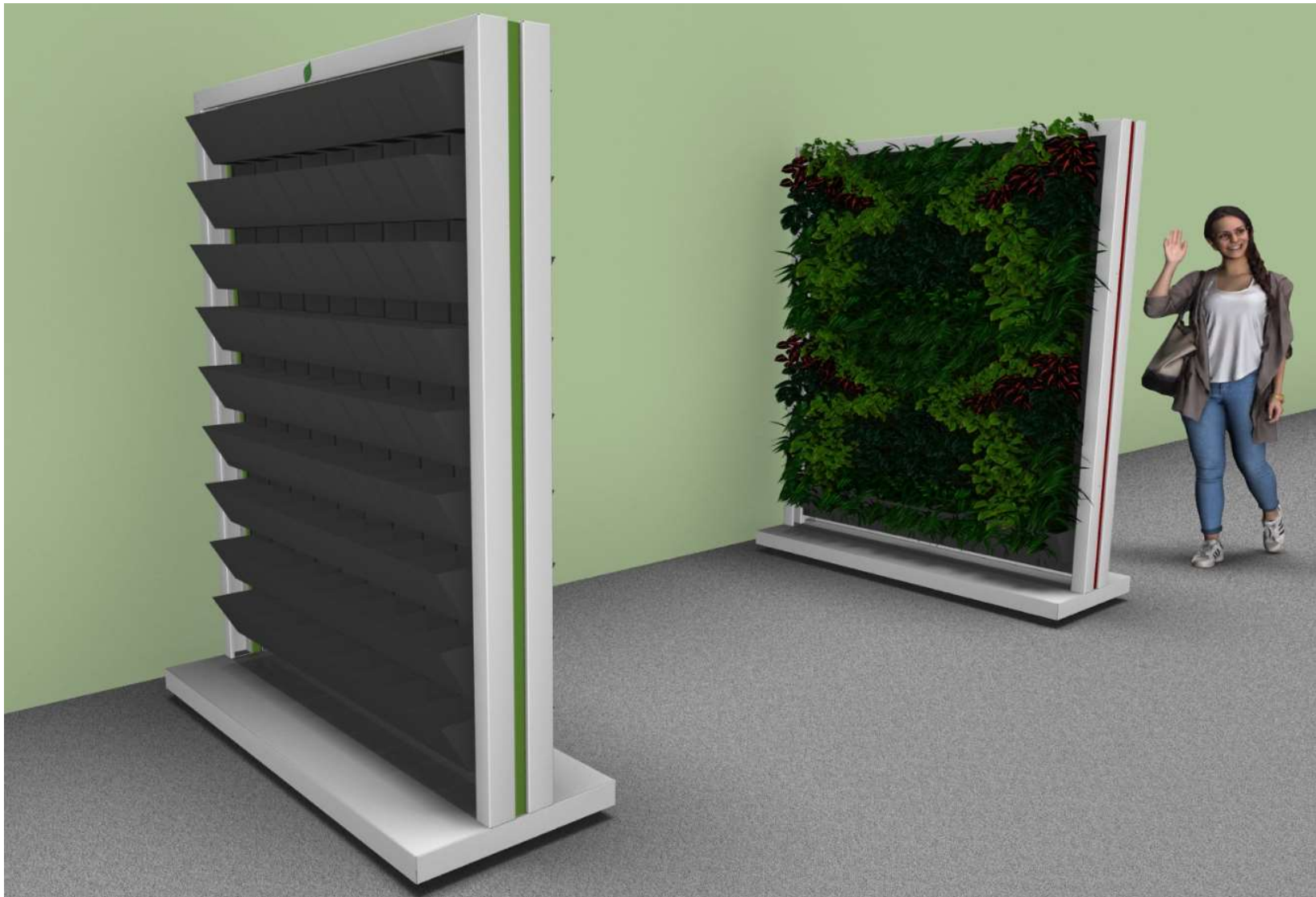







Smart Divider SD 100 x 160

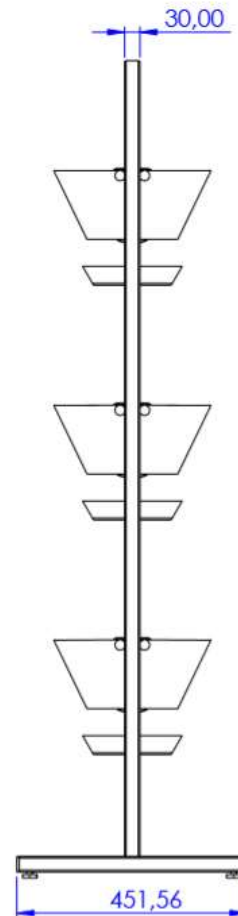
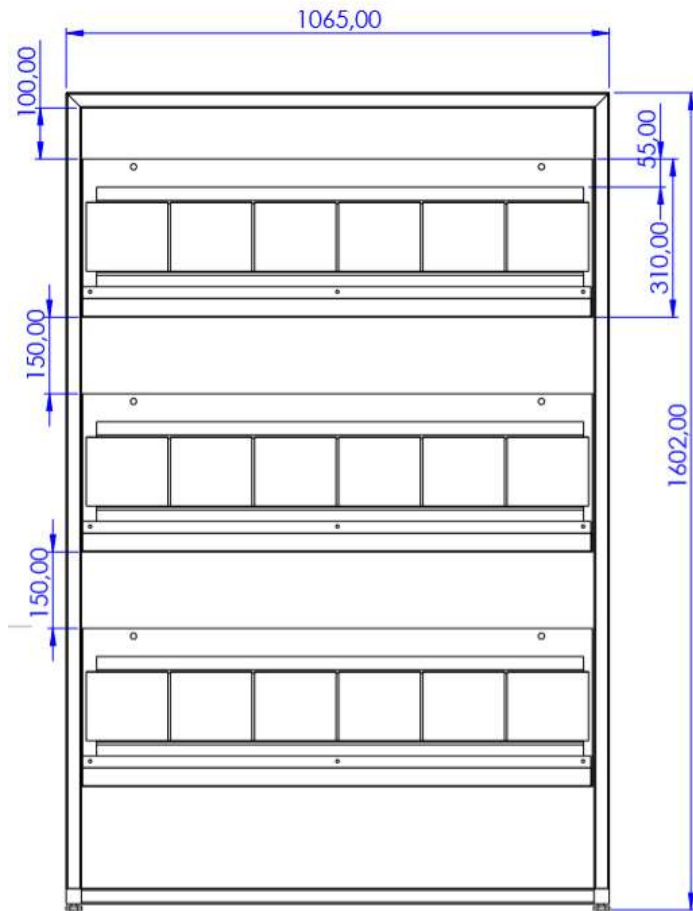

Smart Divider SD 100 x 180

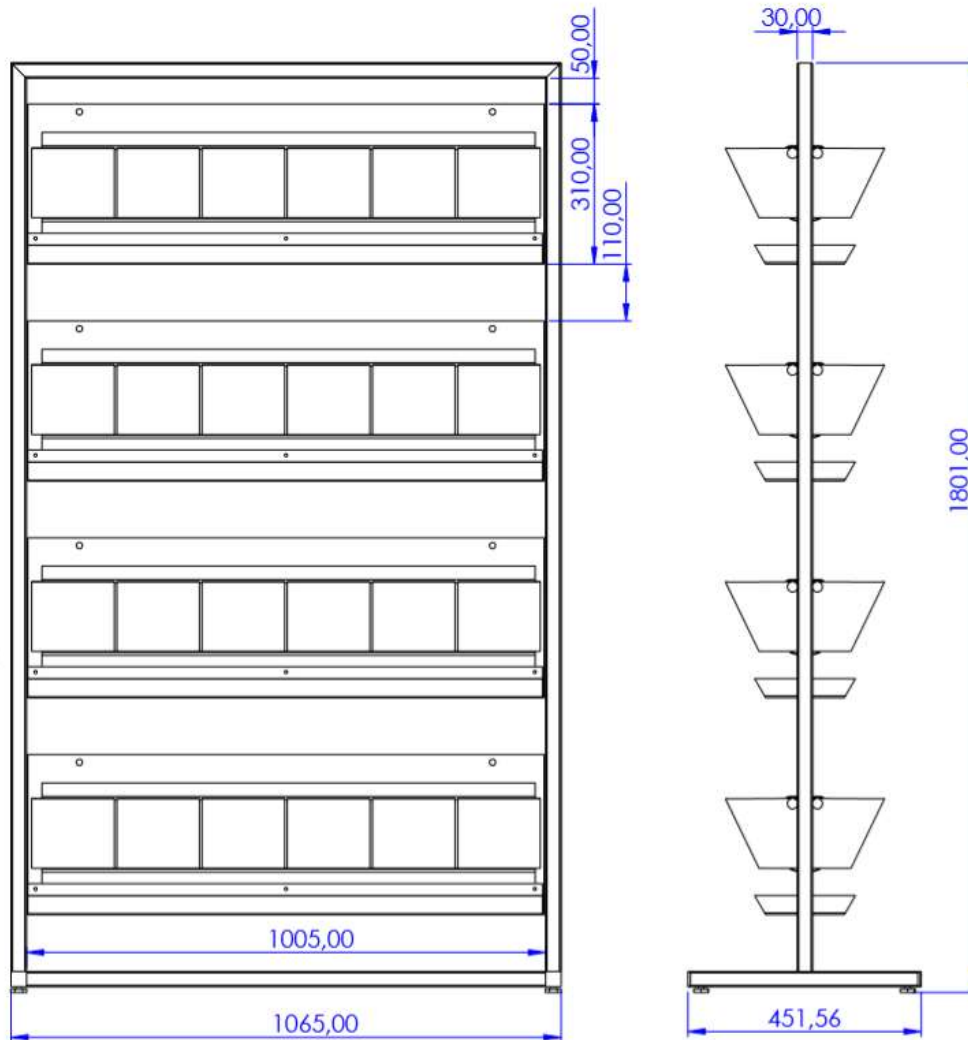

Dünne Berta DB 80 x 200

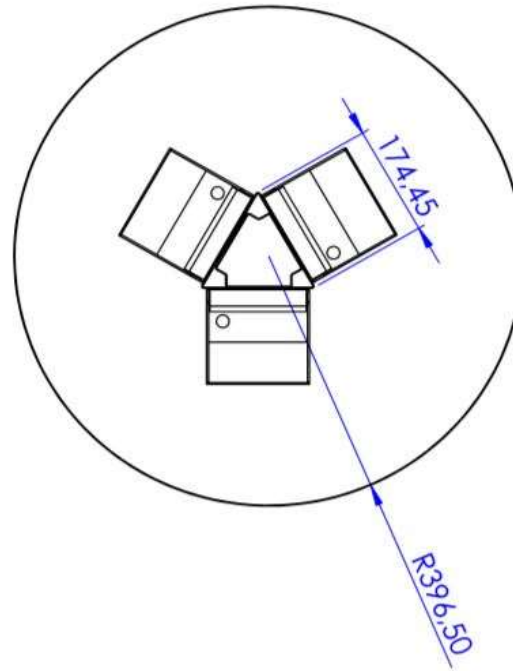
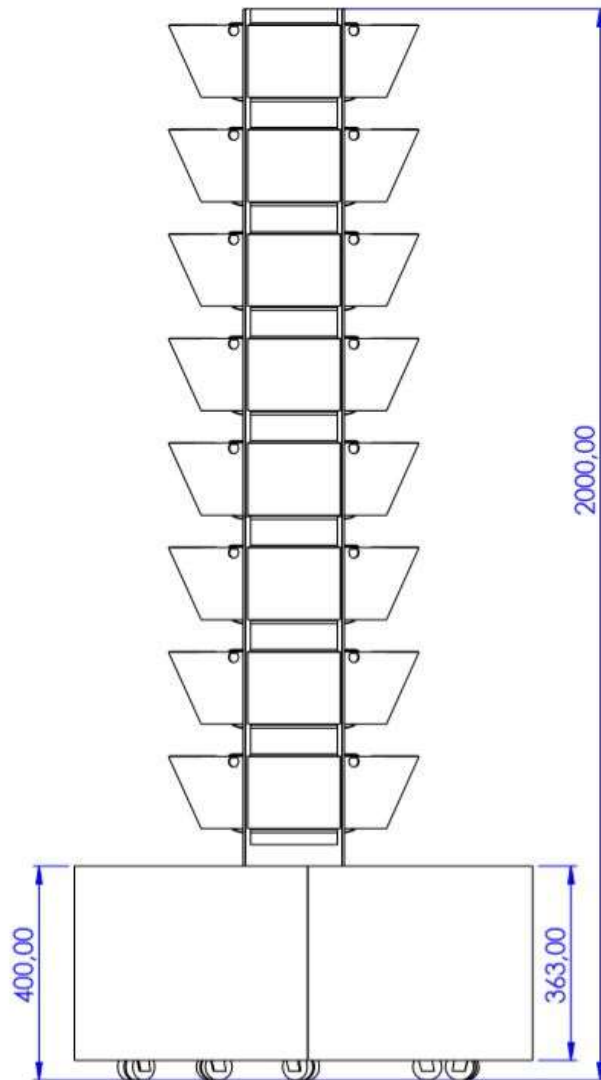

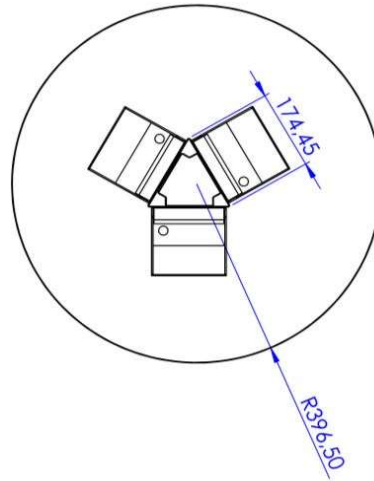
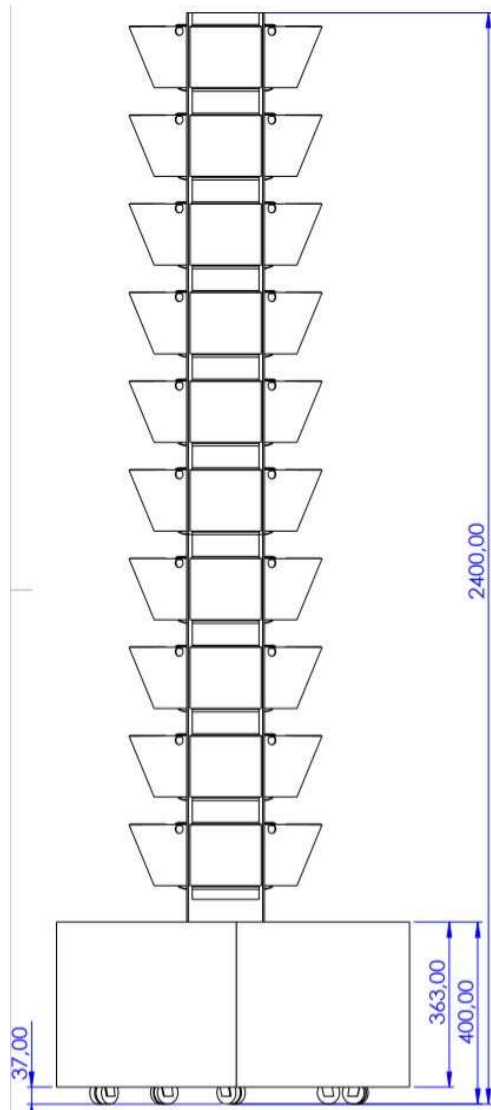

Dünne Berta DB 80 x 240







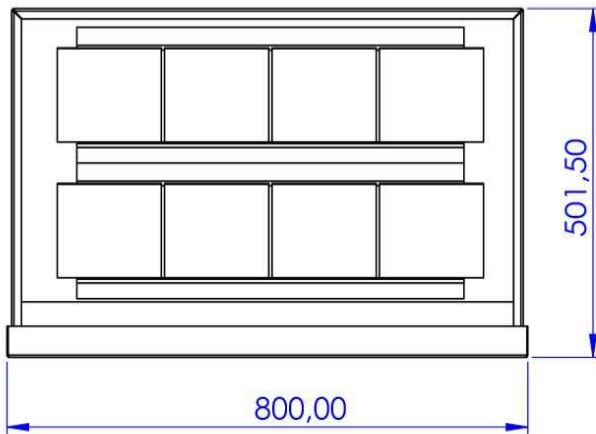

Sideboard Aufsatz / schmaler Rahmen

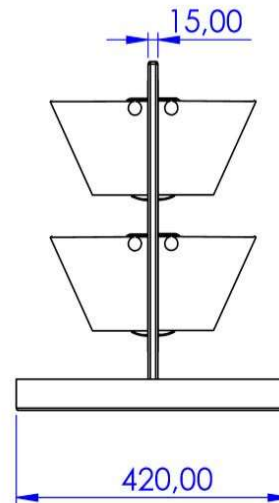

SiBox SlimLine 80 x 50



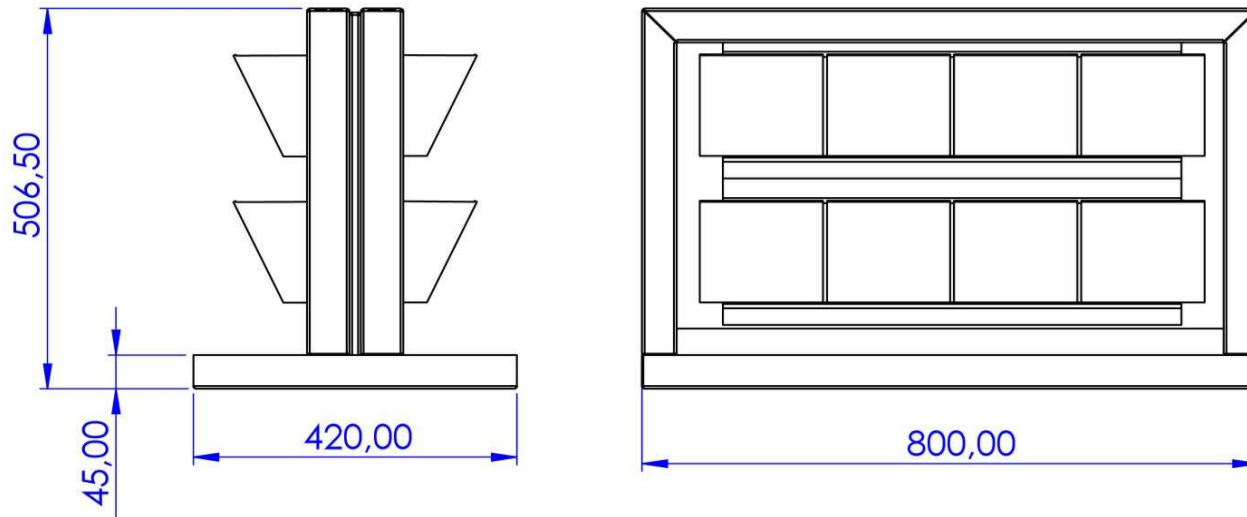

Sideboard Aufsatz / Rahmenoptik MoBox

SiBox 80 x 50



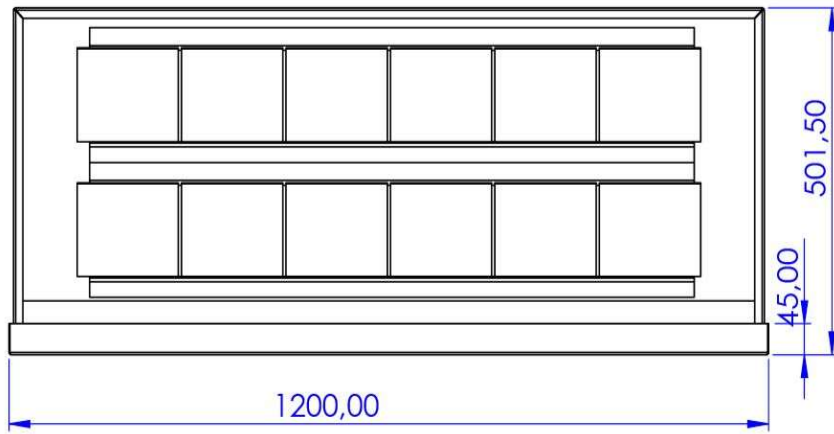

Sideboard Aufsatz / schmaler Rahmen

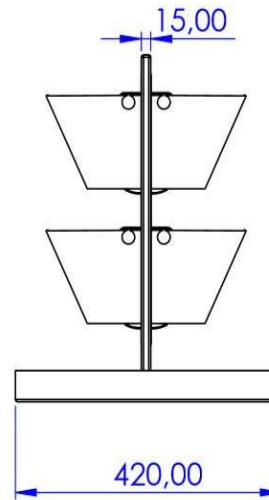

SiBox SlimLine 120 x 50



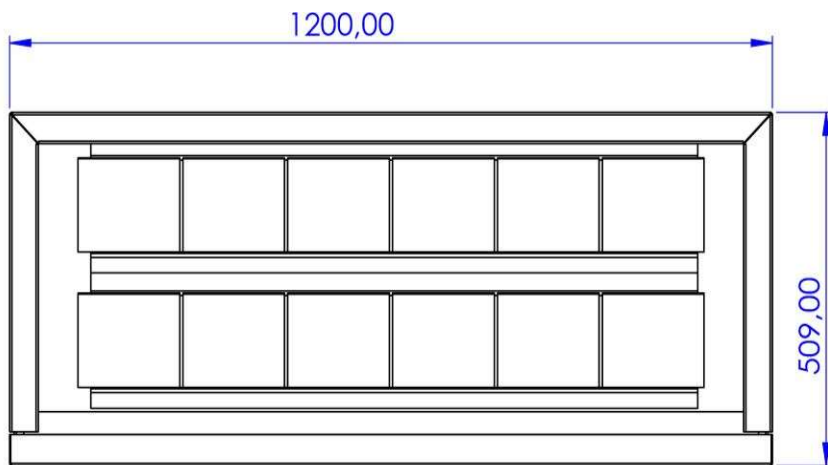

Sideboard Aufsatz / Rahmenoptik MoBox

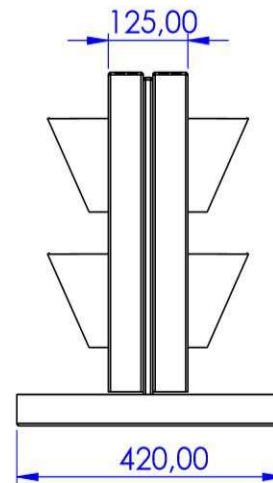

SiBox 120 x 50



FlyBox 100 x 36

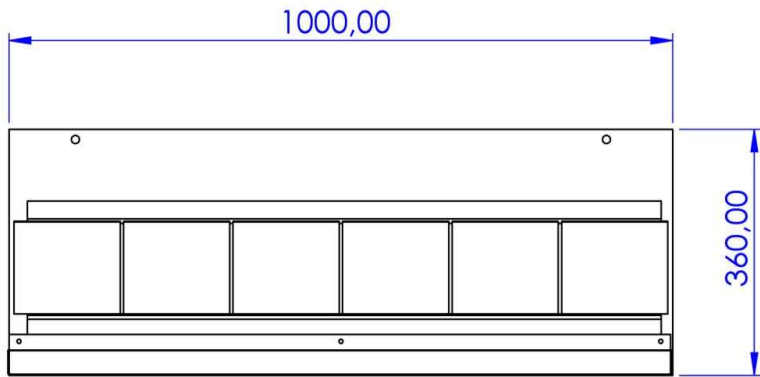

freihängend / beidseitig

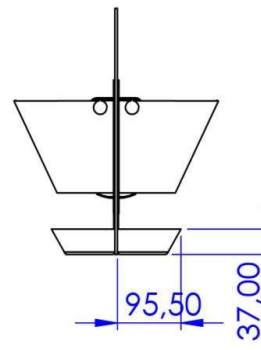

FlyBox 150 x 36

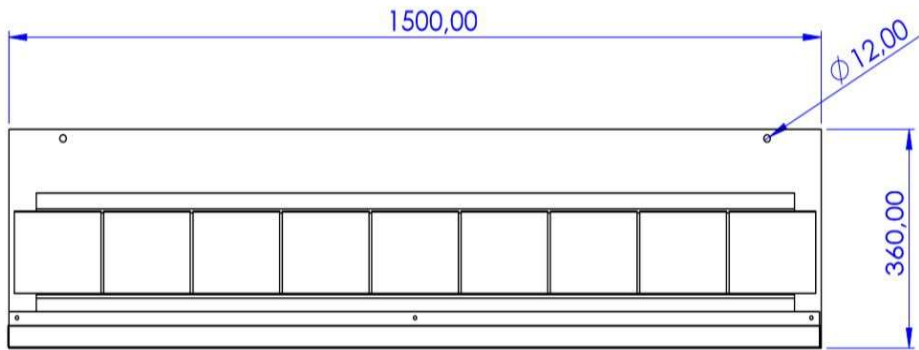

freihängend / beidseitig

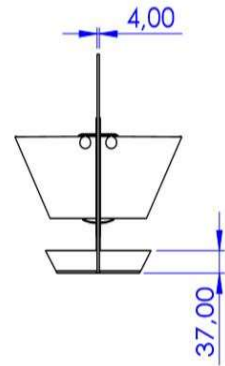





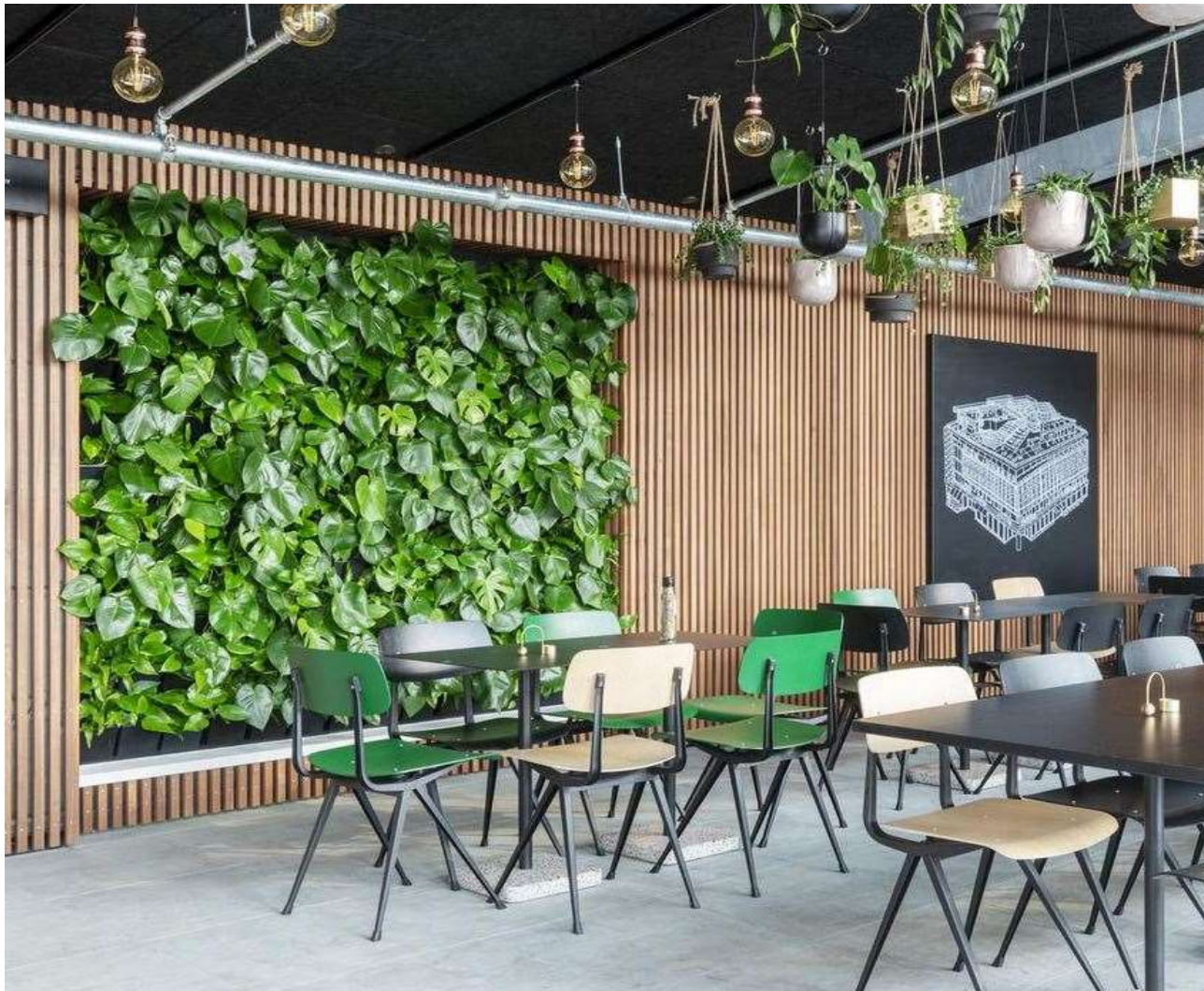

Med venlig hilsen | Best Regards | Mit freundlichen Grüßen

Thomas Berndt

Project Management D | A | CH
Hutzel Hydrokulturen GmbH

Mob.: +49 1717 840 735

Tel.: +49 5403 73750

Mail: NGW@hh-gmbh.net

Web: www.naturalgreenwalls.com

Web: www.hh-gmbh.net

natural  greenwalls®